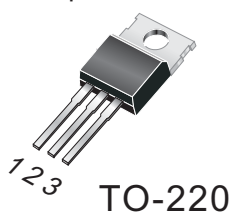

HAOPIN MICROELECTRONICS CO.,LTD.

Description

Standard gate triggering SCR is fully isolated package suitable for the application where requiring high bidirectional blocking voltage capability and also suitable for over voltage protection ,motor control circuit in power tool, inrush current limit circuit and heating control system.

<p>Symbol</p> 		<p>Simplified outline</p>  <p>TO-220</p>	
Pin	Description		
1	Cathode		
2	Anode		
3	Gate		

Applications:

- ◆ Motor control
- ◆ Industrial and domestic lighting
- ◆ Heating
- ◆ Static switching

Features

- ◆ Blocking voltage to 800 V
- ◆ On-state RMS current to 12 A
- ◆ Ultra low gate trigger current

SYMBOL	PARAMETER	Value	Unit
V_{DRM}	Repetitive peak off-state voltages	500R	V
V_{RRM}	Voltages	650R	
		800R	
$I_T (RMS)$	RMS on-state current	12	A
I_{TSM}	Non-repetitive peak on-state current	100	A

SYMBOL	PARAMETER	CONDITIONS	MIN	TYP	MAX	UNIT
$R_{th j-mb}$	Thermal resistance Junction to mounting base		-	-	1.3	K/W
$R_{th j-a}$	Thermal resistance Junction to ambient	In free air	-	60	-	K/W

HAOPIN MICROELECTRONICS CO.,LTD.

Limiting values in accordance with the Maximum system(IEC 134)

SYMBOL	PARAMETER	CONDITIONS	MIN	MAX	UNIT
V_{DRM} V_{RRM}	Repetitive peak off-state Voltages	500R 650R 800R	-	500 650 800	V
I_{TAV}	Average on-state current	Half sine wave; $T_{mb} \leq 109^{\circ}C$	-	7.5	A
$I_{T(RMS)}$	RMS on-state current	All conduction angles	-	12	A
I_{TSM}	Non-repetitive peak On-state current	half sine wave; $T_j = 25^{\circ}C$	-	100	A
		prior to surge	T=10ms T=8.3ms	-	110
I^2t	I^2t for fusing	T=10ms	-	50	A ² S
DI_T/dt	Repetitive rate of rise of on-state current after trigering	$I_{TM}=20A$; $I_G=50mA$; $D_{IG}/dt=50mA/\mu s$	-	50	A/ μs
I_{GM}	Peak gate current		-	2	A
V_{GM}	Peak gate voltage		-	5	V
P_{GM}	Peak gate power		-	5	W
$P_{G(AV)}$	Average gate power	Over any 20 ms period	-	0.5	W
T_{stg}	Storage temperature		-40	150	$^{\circ}C$
T_j	Operating junction Temperature		-	125 ²	$^{\circ}C$

$T_j=25^{\circ}C$ unless otherwise stated

SYMBOL	PARAMETER	CONDITIONS	MIN	TYP	MAX	UNIT
Static characteristics						
I_{GT}	Gate trigger current	$V_D=12V$; $I_T=0.1A$	-	2	15	mA
I_L	Latching current	$V_D=12V$; $I_{GT}=0.1A$	-	10	40	mA
I_H	Holding current	$V_D=12V$; $I_{GT}=0.1A$	-	7	20	mA
V_T	On-state voltage	$I_T=23A$	-	1.4	1.75	V
V_{GT}	Gate trigger voltage	$V_D=12V$; $I_T=0.1A$ $V_D=V_{DRM(max)}$; $I_T=0.1A$; $T_j=125^{\circ}C$	- 0.25	0.6 0.4	1.5 -	V V
I_D	Off-state leakage current	$V_D=V_{DRM(max)}$; $V_R=V_{RRM(max)}$; $T_j=125^{\circ}C$	-	0.1	0.5	mA

Dynamic Characteristics

D_{VD}/dt	Critical rate of rise of Off-state voltage	$V_{DM}=67\% V_{DRM(max)}$; $T_j=125^{\circ}C$; exponential wave form; Gate open circuit $R_{gk}=100\Omega$	50 100	130 1000	-	V/ μs
t_{gt}	Gate controlled turn-on time	$I_{TM}=40A$; $V_D=V_{DRM(max)}$; $I_G=0.1A$; $D_{IG}/dt=5A/\mu s$	-	2	-	μs
t_g	Crcuit commutated tum- off time	$V_{DM}=67\% V_{DRM(max)}$; $T_j=125^{\circ}C$; $I_{TM}=20A$ $V_R=25V$; $dI_{TM}/dt=30A/\mu s$ $D_{IG}/dt=50V/\mu s$; $R_{gk}=100\Omega$	-	70	-	μs

Description

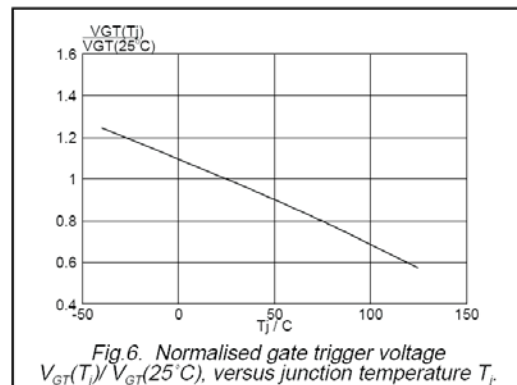
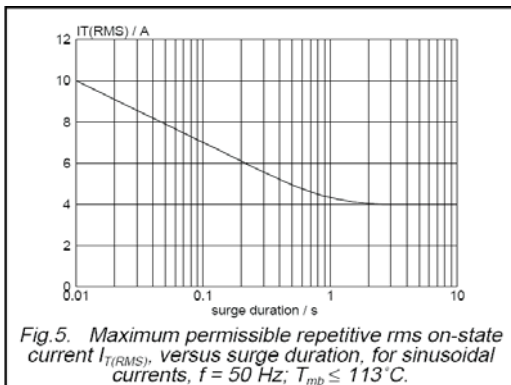
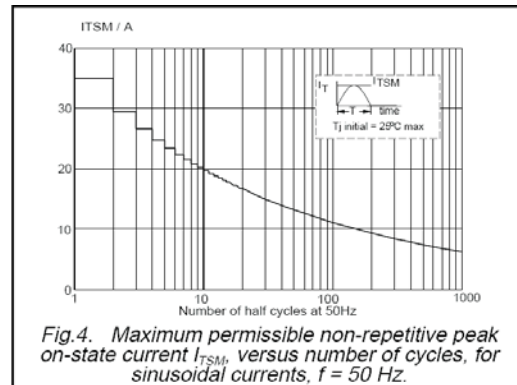
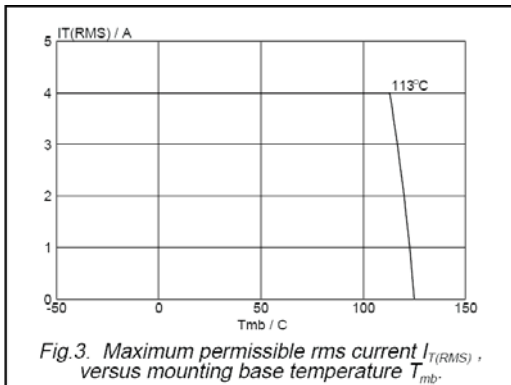
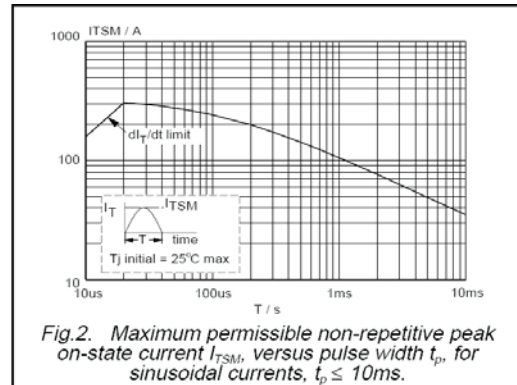
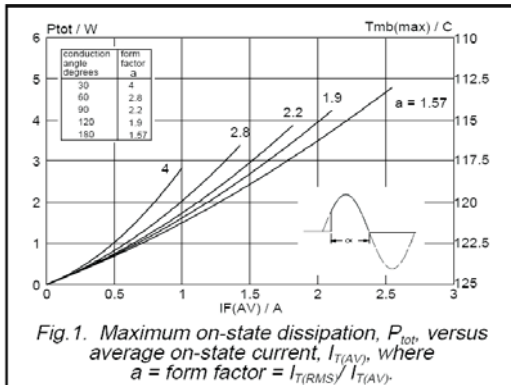

Description

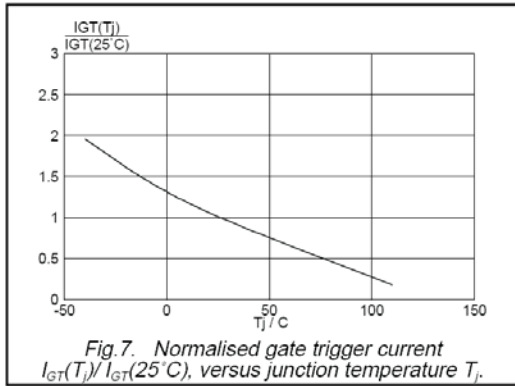

Fig. 7. Normalised gate trigger current $I_{GT}(T_j)/I_{GT}(25^\circ\text{C})$, versus junction temperature T_j .

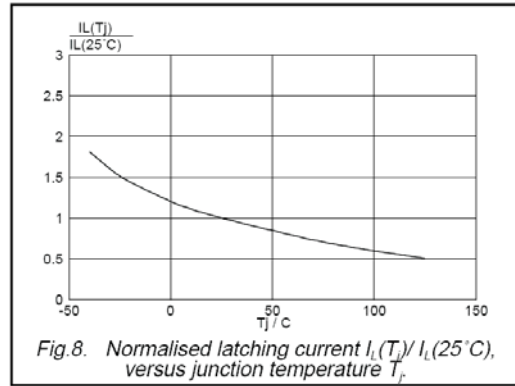

Fig. 8. Normalised latching current $I_L(T_j)/I_L(25^\circ\text{C})$, versus junction temperature T_j .

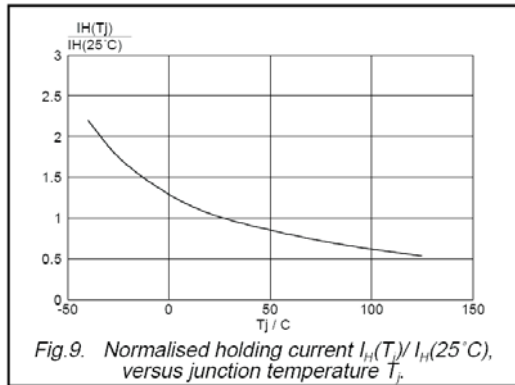

Fig. 9. Normalised holding current $I_H(T_j)/I_H(25^\circ\text{C})$, versus junction temperature T_j .

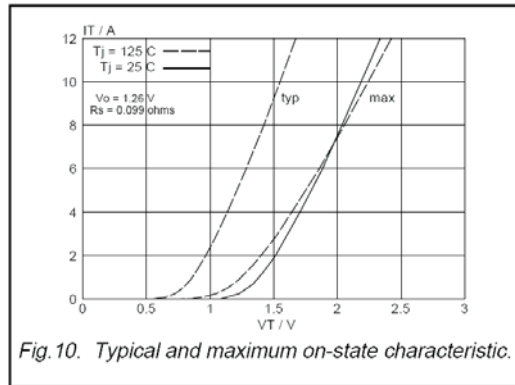

Fig. 10. Typical and maximum on-state characteristic.

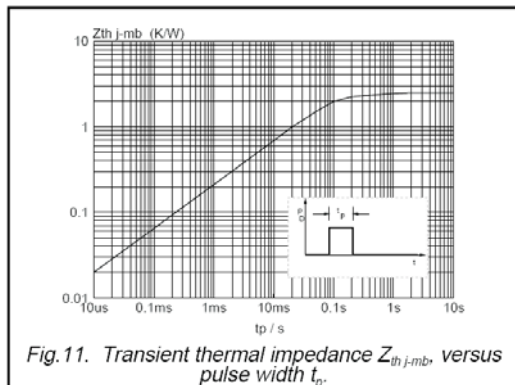

Fig. 11. Transient thermal impedance $Z_{th\ j-mb}$, versus pulse width t_p .

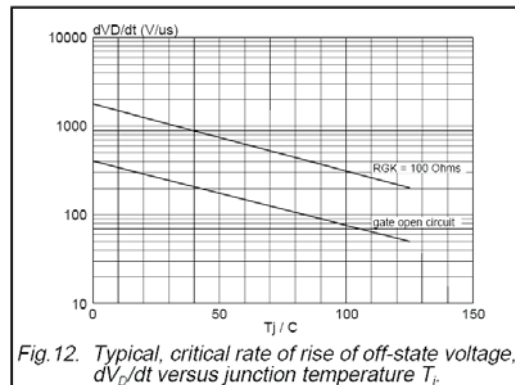

Fig. 12. Typical, critical rate of rise of off-state voltage, dV_p/dt versus junction temperature T_j .

MECHANICAL DATA

