



HAOPIN MICROELECTRONICS CO.,LTD.

Description

Passivated high commutation triacs in a plastic envelope intended for use in circuits where high static and dynamic dV/dt and high dI/dt can occur. These devices will commutate the full rated ms current at the maximum rated junction temperature without the aid of a snubber.

<p>Symbol</p> 		<p>Simplified outline</p> 	
Pin	Description		
1	Main terminal 1 (T1)		
2	Main terminal 2 (T2)		
3	gate (G)		
TAB	isolated		

Applications:

- ◆ Motor control
- ◆ Industrial and domestic lighting
- ◆ Heating
- ◆ Static switching

Features

- ◆ Blocking voltage to 600 V
- ◆ On-state RMS current to 16 A

SYMBOL	PARAMETER	Value	Unit
V_{DRM}	Repetitive peak off-state voltages	600	V
$I_T (RMS)$	RMS on-state current (full sine wave)	16	A
I_{TSM}	Non-repetitive peak on-state current (full cycle, T_j initial=25°C)	168	A

SYMBOL	PARAMETER	CONDITIONS	MIN	TYP	MAX	UNIT
$R_{th(j-c)}$	Junction to case(AC)		-	2.1	-	°C/W
$R_{th(j-a)}$	Junction to ambient		-	60	-	°C/W



BTA16-600CW

Three quadrant triacs

HAOPIN MICROELECTRONICS CO.,LTD.

Limiting values in accordance with the Maximum system(IEC 134)

SYMBOL	PARAMETER	CONDITIONS	MIN	Value	UNIT	
V_{DSM}/V_{RSM}	Non repetitive surge peak off-state voltage	$t_p=10ms$ $T_j=25^\circ C$	-	$V_{DRM}/V_{RRM} +100$	V	
$I_{T(RMS)}$	RMS on-state current	Full sine wave; $T_c=85^\circ C$	-	16	A	
I_{TSM}	Non repetitive surge peak on-state current	full cycle, T_j initial= $25^\circ C$	F=50Hz $t=20ms$	-	160	A
			F=60Hz $t=16.7ms$	-	168	A
I^2t	I^2t Value for fusing	$t_p=10ms$	-	144	A ² S	
di/dt	Critical rate of rise of on-state current	$I_G=2x I_{GT}$, $tr \leq 100ns$	F=120Hz $T_j=125^\circ C$	-	50	A/ μs
I_{GM}	Peak gate current	$t_p=20\mu s$	$T_j=125^\circ C$	-	4	A
I_{DRM}	$V_{DRM}=V_{RRM}$		$T_j=25^\circ C$	-	5	μA
I_{RRM}	$V_{DRM}=V_{RRM}$		$T_j=125^\circ C$	-	2	mA
$P_{G(AV)}$	Average gate power dissipation		$T_j=125^\circ C$	-	1	W
T_{stg}	Storage junction temperature range		-40	150	$^\circ C$	
T_j	Operating junction temperature range		-40	125	$^\circ C$	

$T_j=25^\circ C$ unless otherwise stated

SYMBOL	PARAMETER	CONDITIONS	MIN	TYP	MAX	UNIT
Static characteristics						
$I_{GT}(1)$		$V_D=12V$; $R_L=33\Omega$	I-II-III	-	-	35 mA
V_{GT}			I-II-III			1.3 V
I_L		$I_G=1.2 I_{GT}$	I-III	-	-	50 mA
			II	-	-	60 mA
$I_H(2)$		$I_T=500mA$		-	-	35 mA
V_{GD}		$V_D=V_{DRM}$ $R_L=3.3K\Omega$ $T_j=125^\circ C$	I-II-III	0.2	-	- V
dv/dt(2)		$V_D=67\%V_{DRM}$ gate open; $T_j=125^\circ C$		500	-	- V/ μs
(dv/dt)c(2)		Without snubber; $T_j=125^\circ C$		8.5	-	- A/ms

Dynamic Characteristics

$V_T(2)$	$I_{TM}=22.5A$ $t_p=380\mu s$	$T_j=25^\circ C$	-	-	1.55	V
$V_{to}(2)$	Threshold voltage	$T_j=125^\circ C$	-	-	0.85	V
$R_d(2)$	Dynamic resistance	$T_j=125^\circ C$	-	-	25	m Ω

Note 1 : minimum I_{GT} is guaranteed at 5% of I_{GT} max.

Note 2 : for both polarities of A2 referenced to A1.

Description

Fig. 1: Maximum power dissipation versus RMS on-state current (full cycle).

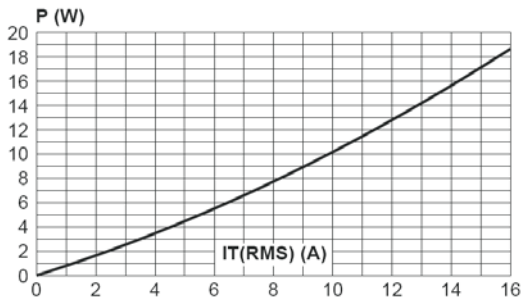

Fig. 2-1: RMS on-state current versus case temperature (full cycle).

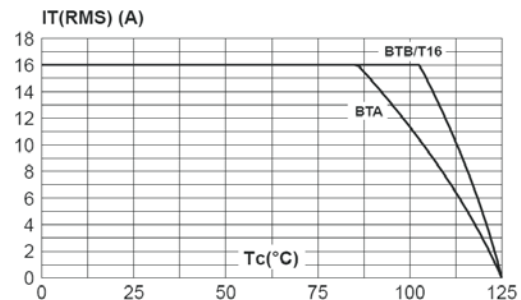

Fig. 2-2: D²PAK RMS on-state current versus ambient temperature (printed circuit board FR4, copper thickness: 35 μm), full cycle.

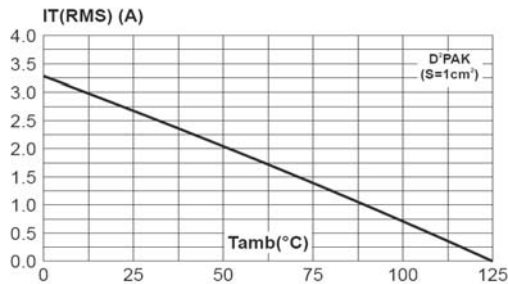

Fig. 3: Relative variation of thermal impedance versus pulse duration.

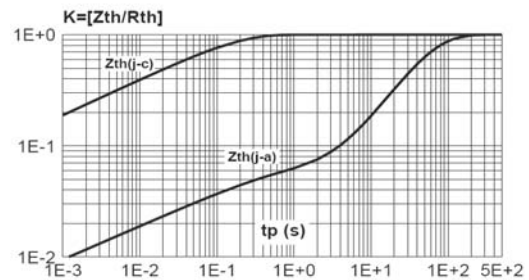

Fig. 4: On-state characteristics (maximum values)

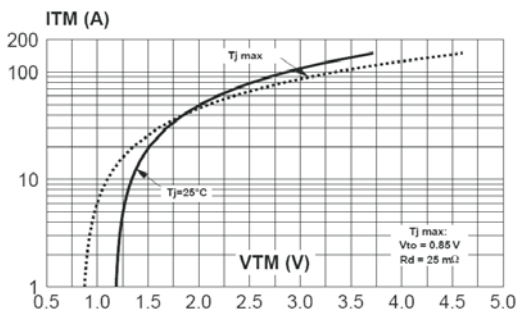
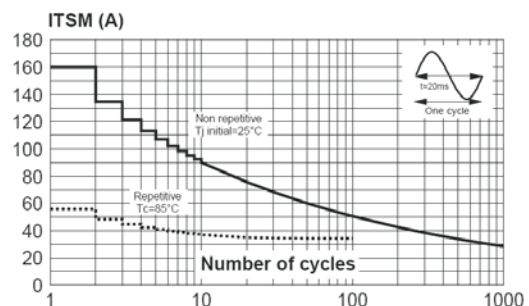

Fig. 5: Surge peak on-state current versus number of cycles.



Description

Fig. 6: Non-repetitive surge peak on-state current for a sinusoidal pulse with width $t_p < 10\text{ms}$, and corresponding value of I^2t .

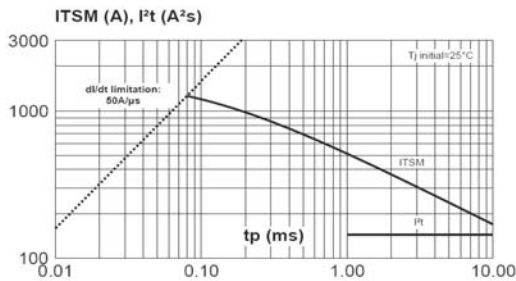

Fig. 7: Relative variation of gate trigger current, holding current and latching current versus junction temperature (typical values).

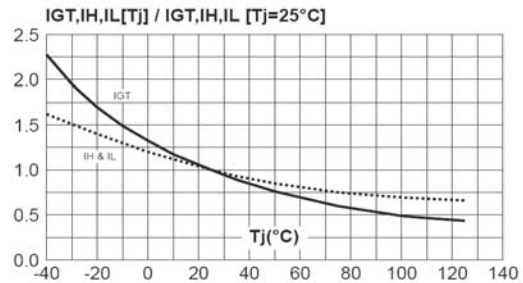

Fig. 8: Relative variation of critical rate of decrease of main current versus $(dV/dt)_c$ (typical values).

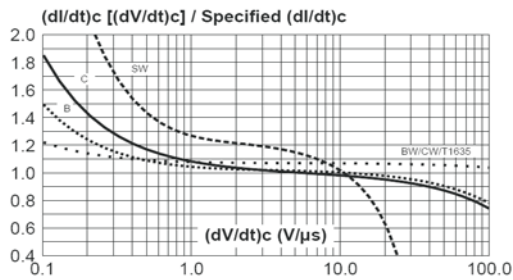

Fig. 9: Relative variation of critical rate of decrease of main current versus junction temperature.

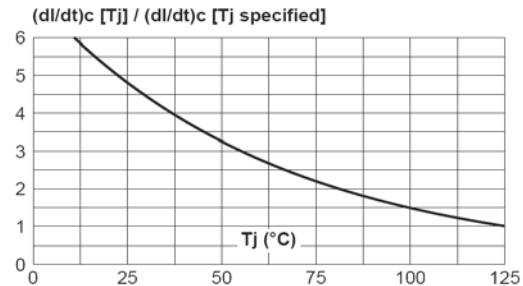
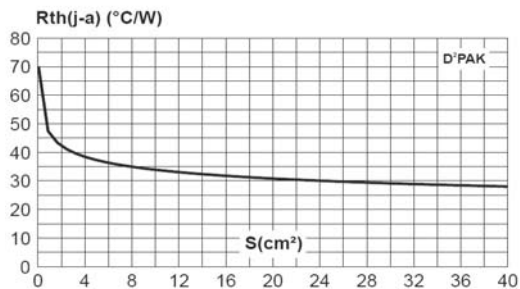
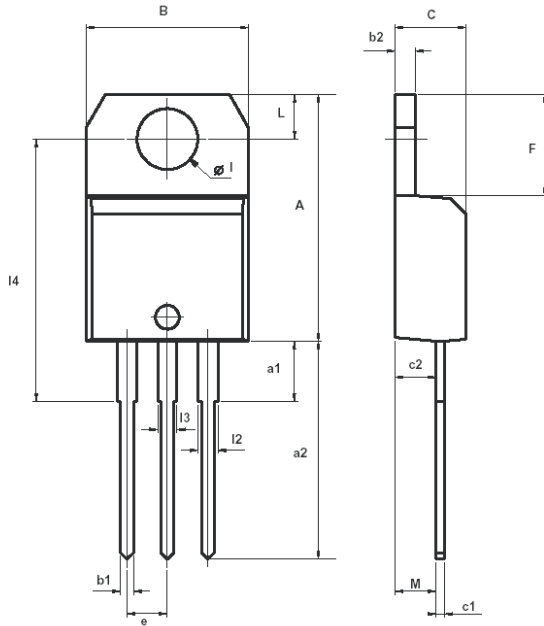

Fig. 10: D²PAK Thermal resistance junction to ambient versus copper surface under tab (printed circuit board FR4, copper thickness: 35 μm).



MECHANICAL DATA

Dimensions in mm
Net Mass: 2 g



REF.	DIMENSIONS					
	Millimeters			Inches		
	Min.	Typ.	Max.	Min.	Typ.	Max.
A	15.20		15.90	0.598		0.625
a1		3.75			0.147	
a2	13.00		14.00	0.511		0.551
B	10.00		10.40	0.393		0.409
b1	0.61		0.88	0.024		0.034
b2	1.23		1.32	0.048		0.051
C	4.40		4.60	0.173		0.181
c1	0.49		0.70	0.019		0.027
c2	2.40		2.72	0.094		0.107
e	2.40		2.70	0.094		0.106
F	6.20		6.60	0.244		0.259
I	3.75		3.85	0.147		0.151
l4	15.80	16.40	16.80	0.622	0.646	0.661
L	2.65		2.95	0.104		0.116
l2	1.14		1.70	0.044		0.066
l3	1.14		1.70	0.044		0.066
M		2.60			0.102	