



### HAOPIN MICROELECTRONICS CO.,LTD.

#### Description

Passivated high commutation triacs in a plastic envelope intended for use in circuits where high static and dynamic  $dV/dt$  and high  $dI/dt$  can occur. These devices will commute the full rated ms current at the maximum rated junction temperature without the aid of a snubber.

<p>Symbol</p> 		<p>Simplified outline</p> 	
Pin	Description		
1	Main terminal 1 (T1)		
2	Main terminal 2 (T2)		
3	gate (G)		
TAB	isolated		

#### Applications:

- ◆ Motor control
- ◆ Industrial and domestic lighting
- ◆ Heating
- ◆ Static switching

#### Features

- ◆ Blocking voltage to 600 V
- ◆ On-state RMS current to 20 A

SYMBOL	PARAMETER	Value	Unit
$V_{DRM}$	Repetitive peak off-state voltages	600	V
$I_{T(RMS)}$	RMS on-state current (full sine wave)	20	A
$I_{TSM}$	Non-repetitive peak on-state current (full cycle, $T_j$ initial=25°C)	200	A

SYMBOL	PARAMETER	CONDITIONS	MIN	TYP	MAX	UNIT
$R_{th(j-c)}$	Junction to case(AC)		-	2.1	-	°C/W
$R_{th(j-a)}$	Junction to ambient		-	60	-	°C/W

### HAOPIN MICROELECTRONICS CO.,LTD.

Limiting values in accordance with the Maximum system(IEC 134)

SYMBOL	PARAMETER	CONDITIONS	MAX	Value	UNIT	
$V_{DRM}$	Repetitive peak off-state Voltages	$T_j=125^{\circ}C$	-	600	V	
$I_{T(RMS)}$	RMS on-state current	$360^{\circ}$ conduction angle $T_c=70^{\circ}C$	-	20	A	
$I_{TSM}$	Non repetitive surge peak on-state current	full cycle, $T_j$ initial= $25^{\circ}C$	$t_p=8.3ms$	-	210	A
			$t_p=10ms$	-	200	A
$I^2t$	$I^2t$ value			$T_p=10ms$	$A^2S$	
$DI/dt$	Critical rate of rise of on-state current	Gate supply: $I_g=500mA$ $dI_g/dt=1A/us$	Repetitive $F=50Hz$	-	20	$A/\mu s$
			Non repetitive	-	100	
$I_{DRM}$	$V_{DRM}$ rated	$T_j=25^{\circ}C$	0.01	-	mA	
$I_{RRM}$	$V_{RRM}$ rated	$T_j=125^{\circ}C$	3	-	mA	
$T_l$	Maximum lead soldering temperature during 10s at 4.5mm form case		-	260	$^{\circ}C$	
$T_{stg}$	Storage and operating junction temperature range		-40	150	$^{\circ}C$	
$T_j$	Storage and operating junction temperature range		-40	125	$^{\circ}C$	

$T_j=25^{\circ}C$  unless otherwise stated

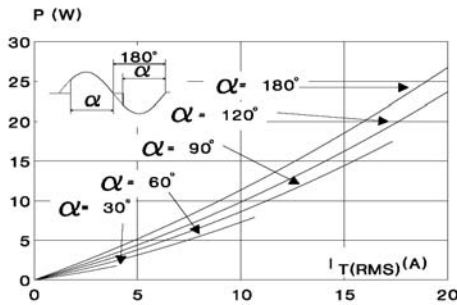
SYMBOL	PARAMETER	CONDITIONS	MIN	TYP	MAX	UNIT	
Static characteristics							
$I_{GT}$	$V_g=12V(DC); R_L=33\Omega$	$T_j=25^{\circ}C$	I-II-III	2	-	50	mA
$V_{GT}$			I-II-III	-	-	1.5	V
$I_L$	$I_g=1.2 I_{GT}$	$T_j=25^{\circ}C$	I-III	-	50	-	mA
			II	-	90	-	
			I-II-III	-	-	-	
$I_H$	$I_T=500mA$ Gate open	$T_j=25^{\circ}C$	-	-	75	mA	
$V_{GD}$	$V_D=V_{DRM}$ $R_L=3.3K\Omega$	$T_j=125^{\circ}C$	I-II-III	0.2	-	-	V
$dV/dt$	$V_D=67\%V_{DRM}$ gate open;	$T_j=125^{\circ}C$		500	750	-	$V/\mu s$
$(dv/dt)_c$	Without snubber	$T_j=125^{\circ}C$		18	36	-	A/ms

#### Dynamic Characteristics

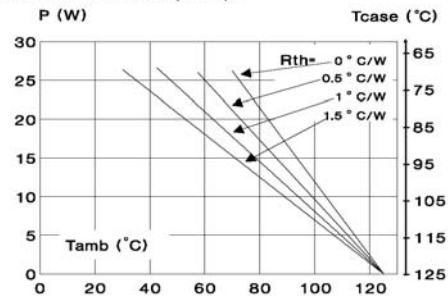
$V_{TM}(2)$	$I_{TM}=28A$ $t_p=380us$	$T_j=25^{\circ}C$	-	-	1.70	V
tgt	$V_D=V_{DRM}$ $I_g=500mA$ $dI_g/dt=3A/us$	$T_j=25^{\circ}C$	I-II-III	-	2	$\mu s$

#### Description

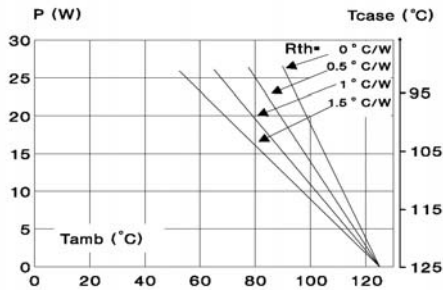
**Fig. 1:** Maximum RMS power dissipation versus RMS on-state current ( $F = 50\text{Hz}$ ). (Curves are cut off by  $(di/dt)_c$  limitation)



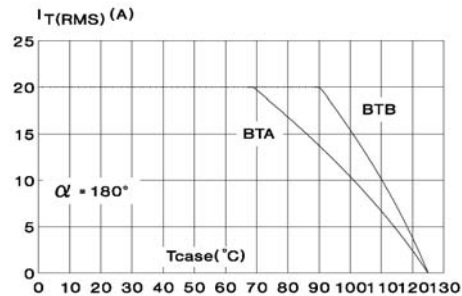
**Fig. 2:** Correlation between maximum RMS power dissipation and maximum allowable temperatures ( $T_{\text{amb}}$  and  $T_{\text{case}}$ ) for different thermal resistances heatsink + contact (BTA).



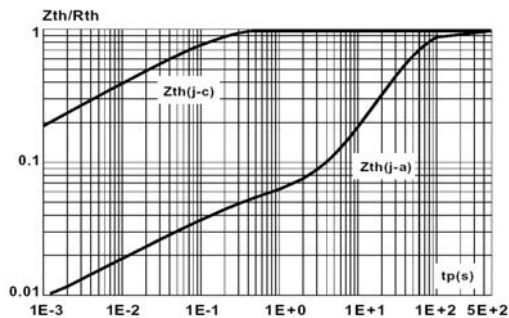
**Fig. 3:** Correlation between maximum RMS power dissipation and maximum allowable temperatures ( $T_{\text{amb}}$  and  $T_{\text{case}}$ ) for different thermal resistances heatsink + contact (BTB).



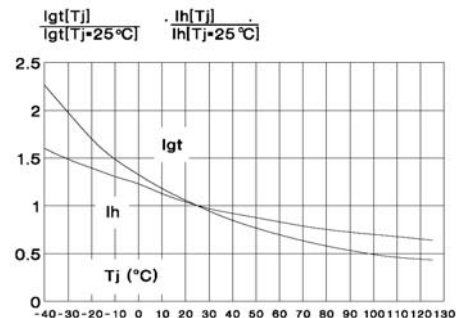
**Fig. 4:** RMS on-state current versus case temperature.



**Fig. 5:** Relative variation of thermal impedance versus pulse duration.

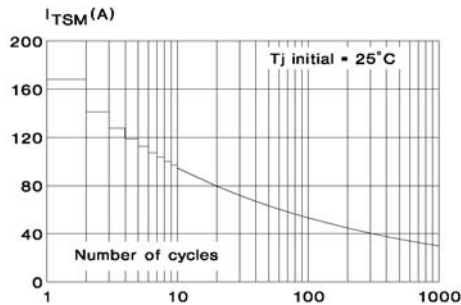


**Fig. 6:** Relative variation of gate trigger current and holding current versus junction temperature.

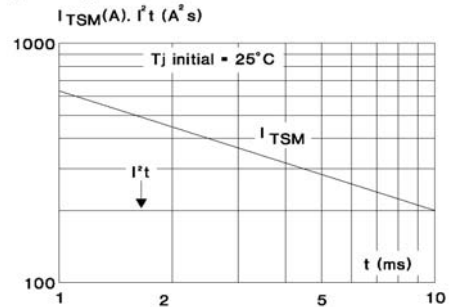


### Description

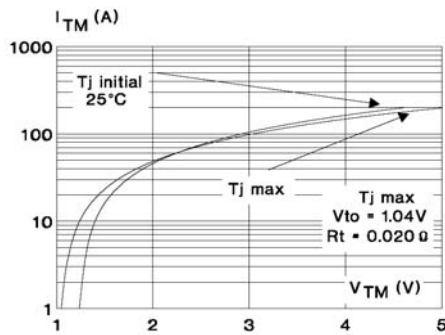
**Fig. 7:** Non repetitive surge peak on-state current versus number of cycles.



**Fig. 8:** Non repetitive surge peak on-state current for a sinusoidal pulse with width:  $t \leq 10\text{ms}$ , and corresponding value of  $I^2t$ .

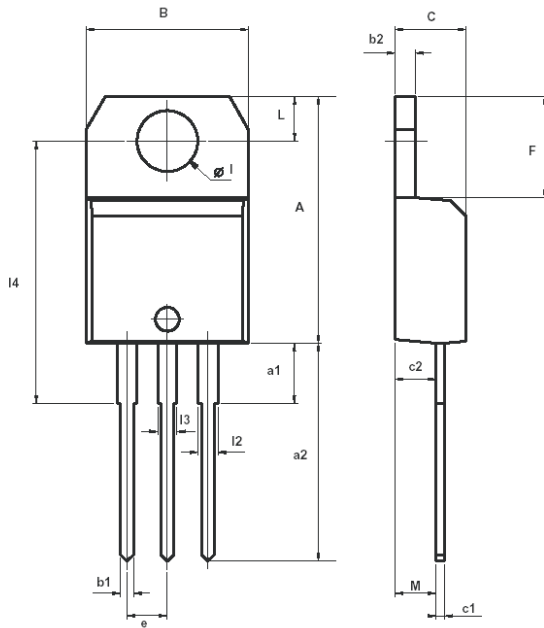


**Fig. 9:** On-state characteristics (maximum values).



### MECHANICAL DATA

Dimensions in mm  
Net Mass: 2 g



REF.	DIMENSIONS					
	Millimeters			Inches		
	Min.	Typ.	Max.	Min.	Typ.	Max.
A	15.20		15.90	0.598		0.625
a1		3.75			0.147	
a2	13.00		14.00	0.511		0.551
B	10.00		10.40	0.393		0.409
b1	0.61		0.88	0.024		0.034
b2	1.23		1.32	0.048		0.051
C	4.40		4.60	0.173		0.181
c1	0.49		0.70	0.019		0.027
c2	2.40		2.72	0.094		0.107
e	2.40		2.70	0.094		0.106
F	6.20		6.60	0.244		0.259
I	3.75		3.85	0.147		0.151
I4	15.80	16.40	16.80	0.622	0.646	0.661
L	2.65		2.95	0.104		0.116
I2	1.14		1.70	0.044		0.066
I3	1.14		1.70	0.044		0.066
M		2.60			0.102	