



### HAOPIN MICROELECTRONICS CO.,LTD.

#### Description

Passivated high commutation triacs in a plastic envelope intended for use in circuits where high static and dynamic  $dV/dt$  and high  $dI/dt$  can occur. These devices will commute the full rated ms current at the maximum rated junction temperature without the aid of a snubber.

<p>Symbol</p> 		<p>Simplified outline</p> 	
Pin	Description		
1	Main terminal 1 (T1)		
2	Main terminal 2 (T2)		
3	gate (G)		
TAB	Main terminal 2 (T2)		

#### Applications:

- ◆ Motor control
- ◆ Industrial and domestic lighting
- ◆ Heating
- ◆ Static switching

#### Features

- ◆ Blocking voltage to 600 V
- ◆ On-state RMS current to 16 A

SYMBOL	PARAMETER	Value	Unit
$V_{DRM}$	Repetitive peak off-state voltages	600	V
$I_T (RMS)$	RMS on-state current	16	A
$I_{TSM}$	Non-repetitive peak on-state current	140	A

SYMBOL	PARAMETER	CONDITIONS	MIN	TYP	MAX	UNIT
$R_{thj-mb}$	Thermal resistance Junction to mounting base	full cycle	-	-	1.2	K/W
		half cycle	-	-	1.7	K/W
$R_{thj-a}$	Thermal resistance Junction to ambient	in free air	-	60	-	K/W



# BTA216-600D

Three quadrant triacs

HAOPIN MICROELECTRONICS CO.,LTD.

Limiting values in accordance with the Maximum system(IEC 134)

SYMBOL	PARAMETER	CONDITIONS	MIN	Value	UNIT	
$V_{DRM}$	Repetitive peak off-state voltages		-	600	V	
$I_{T(RMS)}$	RMS on-state current	Full sine wave; $T_{mb} \leq 99^{\circ}C$	-	16	A	
$I_{TSM}$	Non repetitive surge peak on-state current	Full sine wave; $T_j = 25^{\circ}C$ prior to surge	$t = 20ms$	-	140	A
			$t = 16.7ms$	-	150	A
$I^2t$	$I^2t$ for fusing	$T_p = 10ms$	-	98	A <sup>2</sup> S	
$di_T/dt$	Repetitive rate of rise of on-state current after triggering	$I_{TM} = 20A; I_G = 0.2A;$ $di_G/dt = 0.2A/\mu s$	-	100	A/ $\mu s$	
$I_{GM}$	Peak gate current		-	2	A	
$P_{GM}$	Peak gate power		-	5	W	
$P_{G(AV)}$	Average gate power	Over any 20 ms period	-	0.5	W	
$T_{stg}$	Storage temperature range		-40	150	$^{\circ}C$	
$T_j$	Operating junction Temperature range		-40	125	$^{\circ}C$	

$T_j = 25^{\circ}C$  unless otherwise stated

SYMBOL	PARAMETER	CONDITIONS	MIN	TYP	MAX	UNIT
Static characteristics						
$I_{GT}$	Gate trigger current <sup>2</sup>	$V_D = 12V; I_T = 0.1A$	T2+G+	-	-	5 mA
			T2+G-	-	-	5 mA
			T2-G-	-	-	5 mA
$I_L$	Latching current	$V_D = 12V; I_{GT} = 0.1A$	T2+G+	-	-	15 mA
			T2+G-	-	-	25 mA
			T2-G-	-	-	25 mA
$I_H$	Holding current	$V_D = 12V; I_{GT} = 0.1A$	-	-	15 mA	
$V_T$	On-state voltage	$I_T = 20A$	-	-	1.5 V	
$V_{GT}$	Gate trigger voltage	$V_D = 12V; I_T = 0.1A$ $V_D = 400V; I_T = 0.1A; T_j = 125^{\circ}C$	- 0.25	-	1.5 -	V
$I_D$	Off-state leakage current	$V_D = V_{DRM(max)}; T_j = 125^{\circ}C$	-	-	0.5 mA	

## Dynamic Characteristics

$dV_D/dt$	Critical rate of rise of off-state voltage	$V_{DM} = 67\% V_{DRM(max)}; T_j = 110^{\circ}C$ exponential waveform; gate open circuit	30	-	-	V/ $\mu s$
$di_{com}/dt$	Critical rate of change of commutating current	$V_{DM} = 400V; T_j = 125^{\circ}C; I_{T(RMS)} = 16A$ $dV_{com}/dt = 10V/\mu s$ ; gate open circuit	2.5	-	-	A/ms
$di_{com}/dt$	Critical rate of change of commutating current	$V_{DM} = 400V; T_j = 125^{\circ}C; I_{T(RMS)} = 16A$ $dV_{com}/dt = 10V/\mu s$ ; gate open circuit	12	-	-	A/ms

#### Description

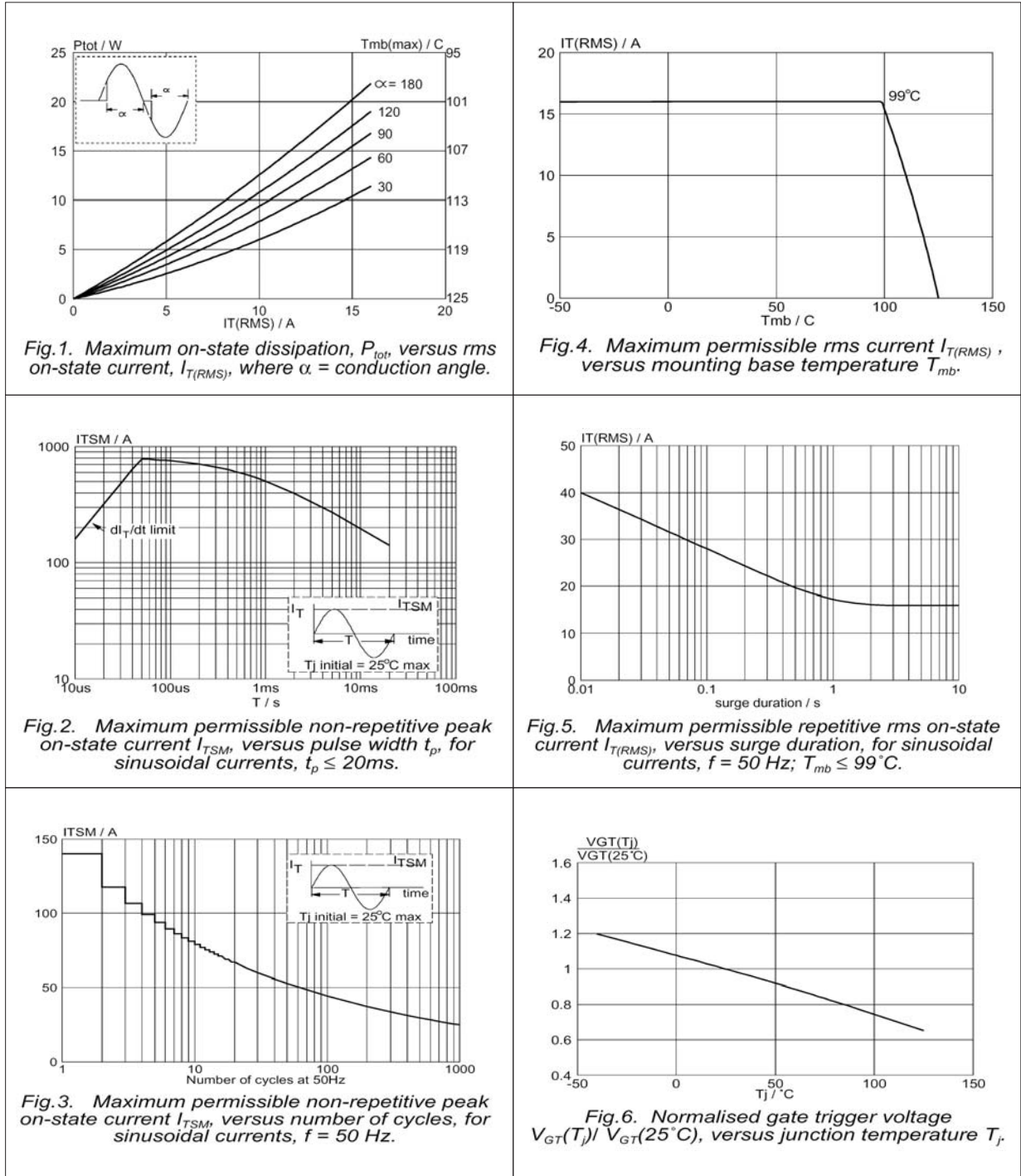

#### Description

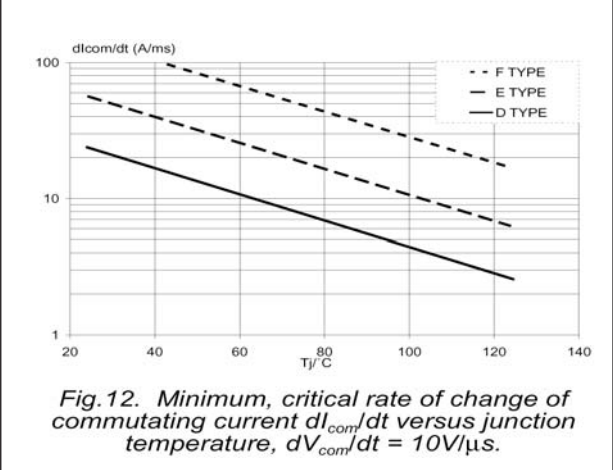
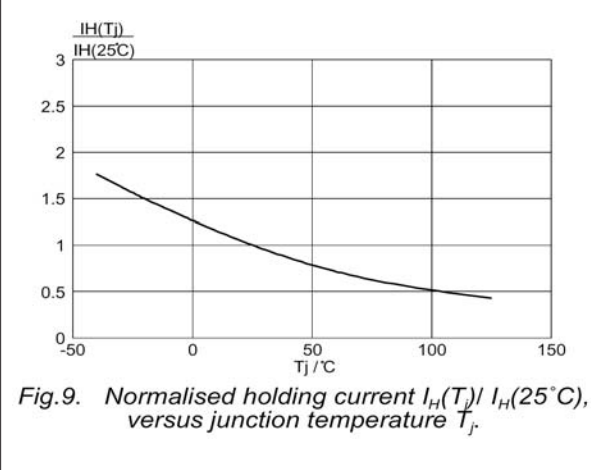
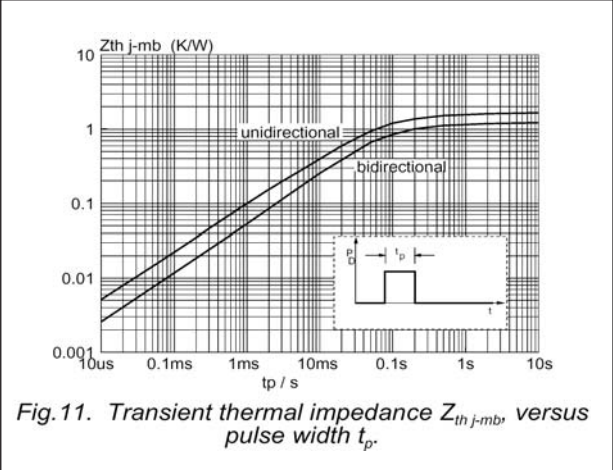
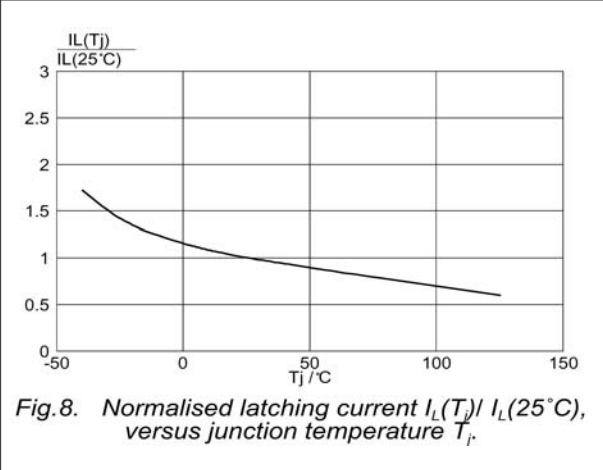
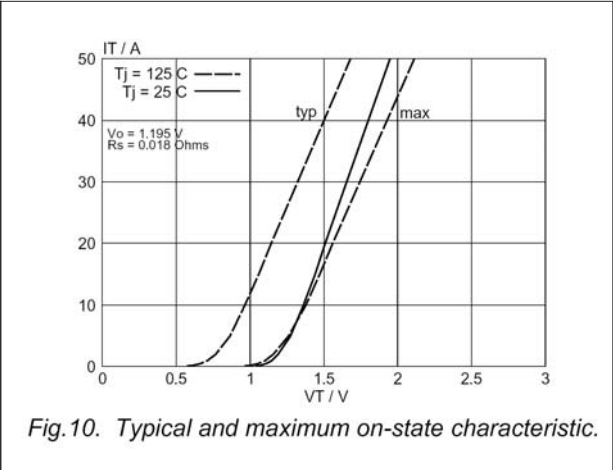
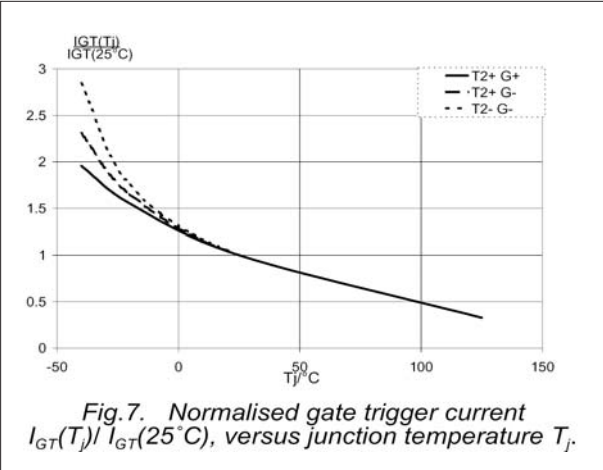

### MECHANICAL DATA

Dimensions in mm  
Net Mass: 2 g

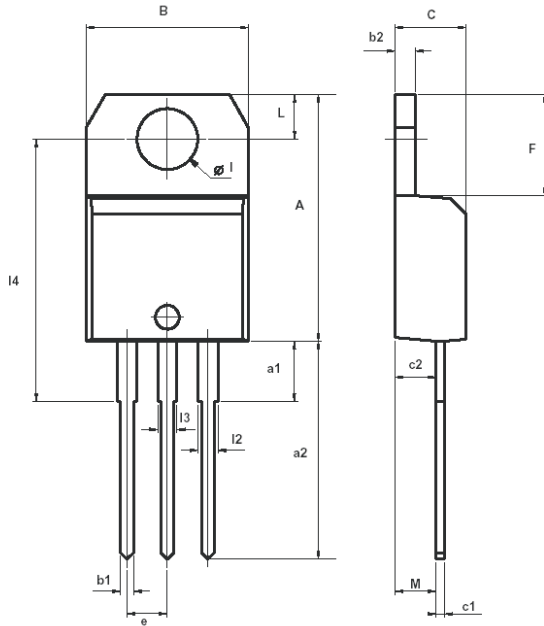

REF.	DIMENSIONS					
	Millimeters			Inches		
	Min.	Typ.	Max.	Min.	Typ.	Max.
A	15.20		15.90	0.598		0.625
a1		3.75			0.147	
a2	13.00		14.00	0.511		0.551
B	10.00		10.40	0.393		0.409
b1	0.61		0.88	0.024		0.034
b2	1.23		1.32	0.048		0.051
C	4.40		4.60	0.173		0.181
c1	0.49		0.70	0.019		0.027
c2	2.40		2.72	0.094		0.107
e	2.40		2.70	0.094		0.106
F	6.20		6.60	0.244		0.259
I	3.75		3.85	0.147		0.151
I4	15.80	16.40	16.80	0.622	0.646	0.661
L	2.65		2.95	0.104		0.116
I2	1.14		1.70	0.044		0.066
I3	1.14		1.70	0.044		0.066
M		2.60			0.102	