



HAOPIN MICROELECTRONICS CO.,LTD.

Description

Passivated high commutation triacs in a plastic envelope intended for use in circuits where high static and dynamic dV/dt and high dI/dt can occur. These devices will commute the full rated ms current at the maximum rated junction temperature without the aid of a snubber.

<p>Symbol</p> 		<p>Simplified outline</p> 	
Pin	Description		
1	Main terminal 1 (T1)		
2	Main terminal 2 (T2)		
3	gate (G)		
TAB	isolated		

Applications:

- ◆ Motor control
- ◆ Industrial and domestic lighting
- ◆ Heating
- ◆ Static switching

Features

- ◆ Blocking voltage to 600 V
- ◆ On-state RMS current to 25 A

SYMBOL	PARAMETER	Value	Unit
V_{DRM}	Repetitive peak off-state voltages	600	V
$I_T (RMS)$	RMS on-state current (full sine wave)	25	A
I_{TSM}	Non-repetitive peak on-state current (full cycle, T_j initial=25°C)	260	A

SYMBOL	PARAMETER	CONDITIONS	MIN	TYP	MAX	UNIT
$R_{th(j-c)}$	Junction to case(AC)		-	1.7	-	°C/W
$R_{th(j-a)}$	Junction to ambient		-	60	-	°C/W

HAOPIN MICROELECTRONICS CO.,LTD.

Limiting values in accordance with the Maximum system(IEC 134)

SYMBOL	PARAMETER	CONDITIONS	MIN	Value	UNIT	
V_{DSM}/V_{RSM}	Non repetitive surge peak off-state voltage	$tp=10ms$ $T_j=25^{\circ}C$	-	$V_{DRM}/V_{RRM} +100$	V	
$I_{T(RMS)}$	RMS on-state current	Full sine wave; $T_c=75^{\circ}C$	-	25	A	
I_{TSM}	Non repetitive surge peak on-state current	full cycle, T_j initial= $25^{\circ}C$	$F=50Hz$ $t=20ms$	-	250	A
			$F=60Hz$ $t=16.7ms$	-	260	A
I^2t	I^2t Value for fusing	$T_p=10ms$	-	340	A^2S	
DI/dt	Critical rate of rise of on-state current	$IG=2x I_{GT}, tr \leq 100ns$ $F=120Hz$ $T_j=125^{\circ}C$	-	50	$A/\mu s$	
I_{GM}	Peak gate current	$tp=20\mu s$ $T_j=125^{\circ}C$	-	4	A	
I_{DRM}	$V_{DRM}=V_{RRM}$	$T_j=25^{\circ}C$	-	5	μA	
I_{RRM}	$V_{DRM}=V_{RRM}$	$T_j=125^{\circ}C$	-	3	mA	
$P_{G(AV)}$	Average gate power	$T_j=125^{\circ}C$	-	1	W	
T_{stg}	Storage temperature range		-40	150	$^{\circ}C$	
T_j	Operating junction Temperature range		-40	125	$^{\circ}C$	

$T_j=25^{\circ}C$ unless otherwise stated

SYMBOL	PARAMETER	CONDITIONS	MIN	TYP	MAX	UNIT
Static characteristics						
I_{GT1} V_{GT}		$V_D=12V; RL=33\Omega$ I-II-III I-II-III	-	-	50 1.3	mA V
I_L		$I_G=1.2 I_{GT}$ I-III II	- -	- -	80 100	mA mA
I_H^2		$I_T=500mA$	-	-	75	mA
V_{GD}		$V_D=V_{DRM}$ $R_L=3.3K\Omega$ $T_j=125^{\circ}C$ I-II-III	0.2	-	-	V
$dV/dt2$		$V_D=67\%V_{DRM}$ gate open; $T_j=125^{\circ}C$	1000	-	-	$V/\mu s$
$(Dv/dt)c(2)$		Without snubber; $T_j=125^{\circ}C$	22	-	-	A/ms

Dynamic Characteristics

$V_{TM}(2)$	$I_{TM}=35A$ $tp=380\mu s$	$T_j=25^{\circ}C$	-	-	1.55	V
V_{to} R_d	Threshold voltage Dynamic resistance	$T_j=125^{\circ}C$ $T_j=125^{\circ}C$	-	-	0.85 16	V $m\Omega$

HAOPIN MICROELECTRONICS CO.,LTD.

Description

Fig. 1: Maximum power dissipation versus RMS on-state current (full cycle).

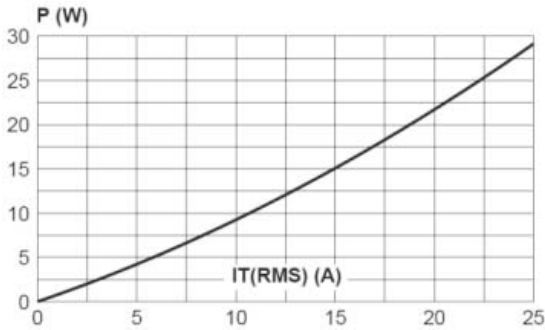

Fig. 2-1: RMS on-state current versus case temperature (full cycle).

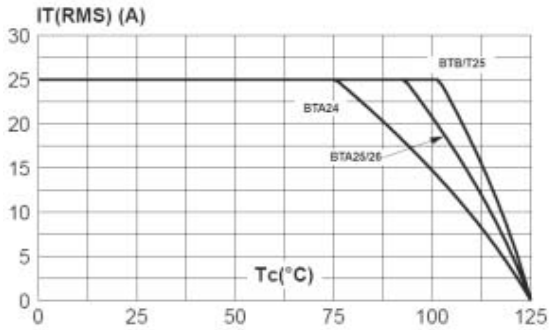

Fig. 2-2: D²PAK RMS on-state current versus ambient temperature (printed circuit board FR4, copper thickness: 35 μm), full cycle.

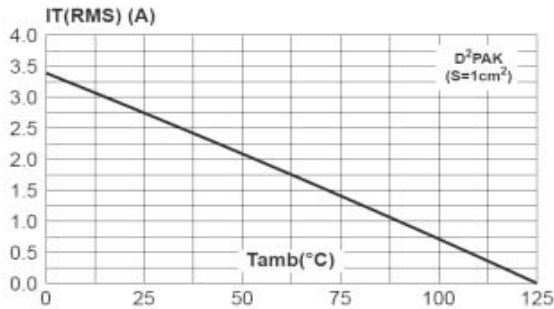

Fig. 3: Relative variation of thermal impedance versus pulse duration.

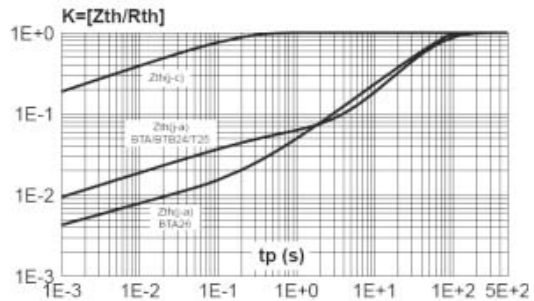

Fig. 4: On-state characteristics (maximum values).

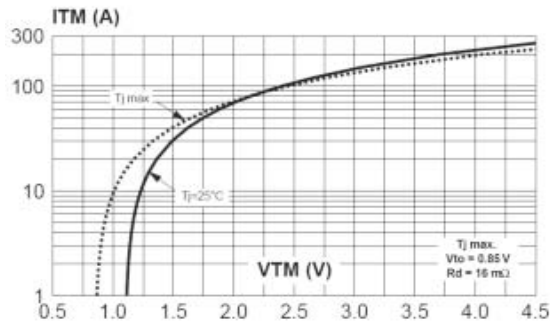
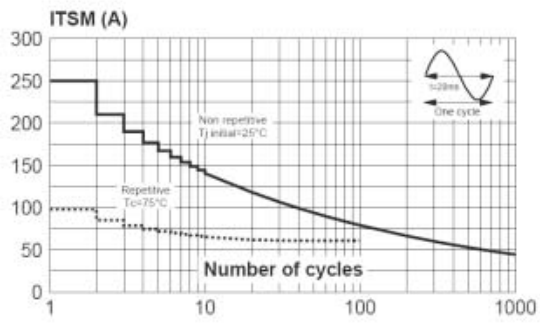

Fig. 5: Surge peak on-state current versus number of cycles.



Description

Fig. 6: Non-repetitive surge peak on-state current for a sinusoidal pulse with width $t_p < 10\text{ms}$, and corresponding value of I^2t .

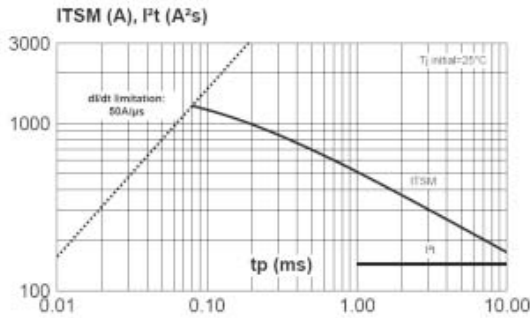

Fig. 7: Relative variation of gate trigger current, holding current and latching current versus junction temperature (typical values).

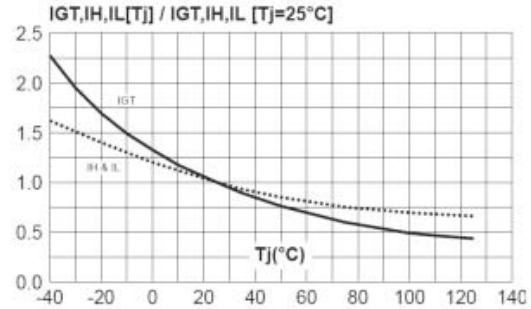

Fig. 8: Relative variation of critical rate of decrease of main current versus $(dV/dt)_c$ (typical values).

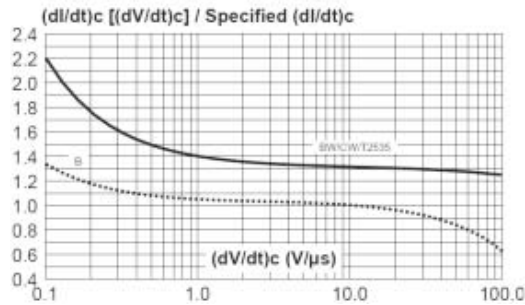

Fig. 9: Relative variation of critical rate of decrease of main current versus junction temperature.

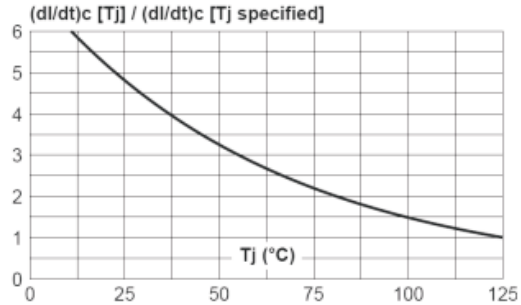
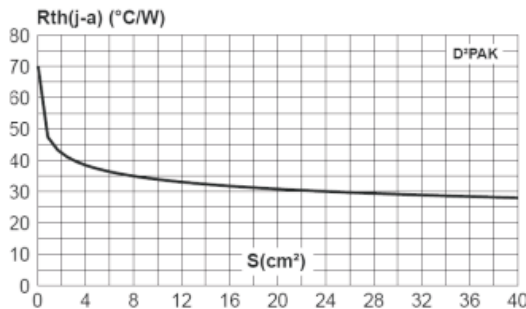
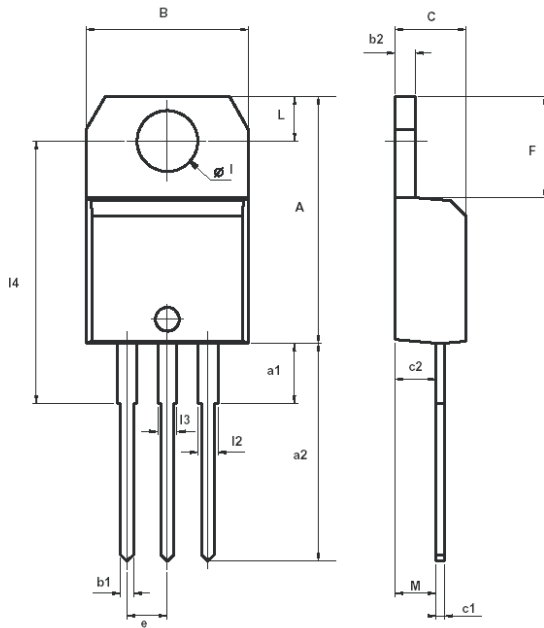

Fig. 10: D²PAK Thermal resistance junction to ambient versus copper surface under tab (printed circuit board FR4, copper thickness: 35 μm).



MECHANICAL DATA

Dimensions in mm
Net Mass: 2 g



REF.	DIMENSIONS					
	Millimeters			Inches		
	Min.	Typ.	Max.	Min.	Typ.	Max.
A	15.20		15.90	0.598		0.625
a1		3.75			0.147	
a2	13.00		14.00	0.511		0.551
B	10.00		10.40	0.393		0.409
b1	0.61		0.88	0.024		0.034
b2	1.23		1.32	0.048		0.051
C	4.40		4.60	0.173		0.181
c1	0.49		0.70	0.019		0.027
c2	2.40		2.72	0.094		0.107
e	2.40		2.70	0.094		0.106
F	6.20		6.60	0.244		0.259
I	3.75		3.85	0.147		0.151
I4	15.80	16.40	16.80	0.622	0.646	0.661
L	2.65		2.95	0.104		0.116
I2	1.14		1.70	0.044		0.066
I3	1.14		1.70	0.044		0.066
M		2.60			0.102	