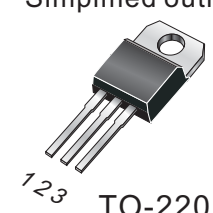

HAOPIN MICROELECTRONICS CO.,LTD.

Description

Passivated high commutation triacs in a plastic envelope intended for use in circuits where high static and dynamic dV/dt and high dI/dt can occur. These devices will commutate the full rated ms current at the maximum rated junction temperature without the aid of a snubber.

<p>Symbol</p> 		<p>Simplified outline</p> 	
Pin	Description		
1	Main terminal 1 (T1)		
2	Main terminal 2 (T2)		
3	gate (G)		
TAB	isolated		

Applications:

- ◆ Motor control
- ◆ Industrial and domestic lighting
- ◆ Heating
- ◆ Static switching

Features

- ◆ Blocking voltage to 600 V
- ◆ On-state RMS current to 16 A

SYMBOL	PARAMETER	Value	Unit
V_{DRM}	Repetitive peak off-state voltages	600	V
$I_T (RMS)$	RMS on-state current (full sine wave)	16	A
I_{TSM}	Non-repetitive peak on-state current (full cycle, T_j initial=25°C)	167	A

SYMBOL	PARAMETER	CONDITIONS	MIN	TYP	MAX	UNIT
R_{thj-mb}	Thermal resistance Junction to mounting base	full cycle	-	-	1.2	K/W
		half cycle	-	-	1.7	
R_{thj-a}	Thermal resistance Junction to ambient	in free air	-	60	-	K/W

HAOPIN MICROELECTRONICS CO.,LTD.

Limiting values in accordance with the Maximum system(IEC 134)

SYMBOL	PARAMETER	CONDITIONS	MIN	Value	UNIT
V_{DRM}	Repetitive peak off-state voltages		-	600	V
$I_{T(RMS)}$	RMS on-state current		-	16	A
I_{TSM}	Non repetitive surge peak on-state current	full sine wave; $T_j = 25^\circ\text{C}$ prior to surge	-	200 167	A A
I^2t	I^2t for fusing	$t=10\text{ms}$	-	166	A^2S
di/dt	Repetitive rate of rise of on-state current after triggering	$I_{TM}=20\text{A}; I_G=0.2A_T,$ $di_G/dt=0.2A/\mu\text{s}$	-	100	$\text{A}/\mu\text{s}$
I_{GTM}	Peak gate current		-	2	A
P_{GM}	Peak gate power		-	20	W
$P_{G(AV)}$	Average gate power	over any 20 ms period	-	0.5	W
T_{stg}	Storage temperature		-40	150	$^\circ\text{C}$
T_j	Operating junction temperature		-	125	$^\circ\text{C}$

$T_j=25^\circ\text{C}$ unless otherwise stated

SYMBOL	PARAMETER	CONDITIONS	MIN	TYP	MAX	UNIT
I_{GT}	Gate trigger current	$V_D=12\text{V}; I_T=0.1\text{A}$	-	-	35	mA
		QI	-	-	35	mA
		QII	-	-	35	mA
		QIII	-	-	35	mA
V_{GT}	Gate trigger voltage	$T_c=25^\circ\text{C}$	-	-	2	V
I_{DRM}	Latching current	$T_c=25^\circ\text{C}$	-	-	0.05	mA
		$T_c=100^\circ\text{C}$	-	-	0.5	mA
		$T_c=125^\circ\text{C}$	-	-	2	mA
I_H	Holding current	$V_D=12\text{V}; I_{GT}=0.1\text{A}$	-	-	50	mA
V_{TM}	On-state voltage	$T_c=25^\circ\text{C}$	-	-	1.6	V
$dV/dt(c)$	Critical rate of rise of off-state voltage	$V_{DM}=67\%V_{DRM(max)}; T_j=110^\circ\text{C};$ exponential waveform; gate open circuit	25	-	-	$\text{V}/\mu\text{s}$

Dynamic Characteristics

di_{com}/dt	Critical rate of change of commutating current	$V_{DM}=400\text{V}; T_j=125^\circ\text{C}; I_{T(RMS)}=16\text{A};$ $dV_{com}/dt=10\text{V}/\mu\text{s};$ gate open circuit	18	-	-	A/ms
di_{com}/dt	Critical rate of change of commutating current	$V_{DM}=400\text{V}; T_j=125^\circ\text{C}; I_{T(RMS)}=16\text{A};$ $dV_{com}/dt=0.1\text{V}/\mu\text{s};$ gate open circuit	50	-	-	A/ms

Note 1 : Although not recommended, off-state voltages up to 800V may be applied without damage ,but the triac may switch to the on-state .the rate of current should not exceed 15A/us.

Note 2 : Device does not trigger in the T2-,G+ quadrant.

Description

Fig. 1: Maximum power dissipation versus RMS on-state current (full cycle).

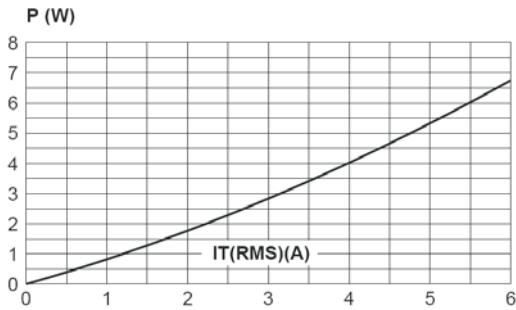

Fig. 2: RMS on-state current versus case temperature (full cycle).

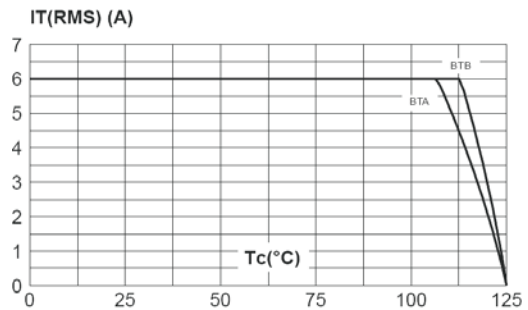

Fig. 3: Relative variation of thermal impedance versus pulse duration.

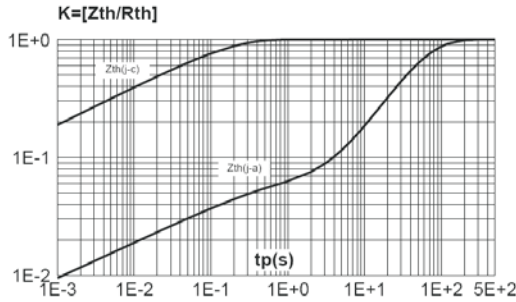

Fig. 4: On-state characteristics (maximum values).

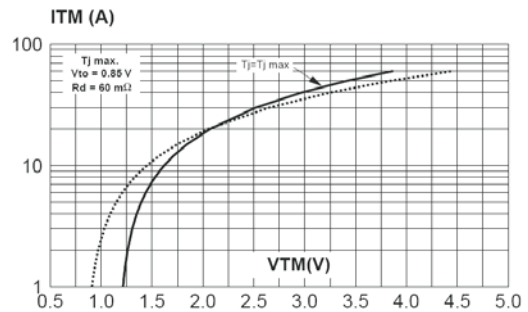

Fig. 5: Surge peak on-state current versus number of cycles.

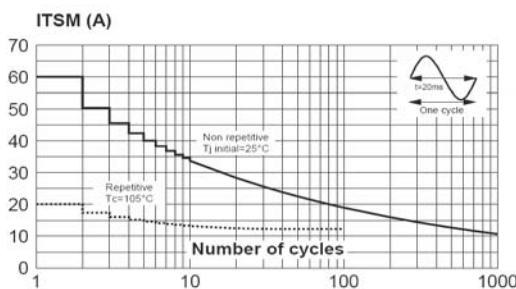
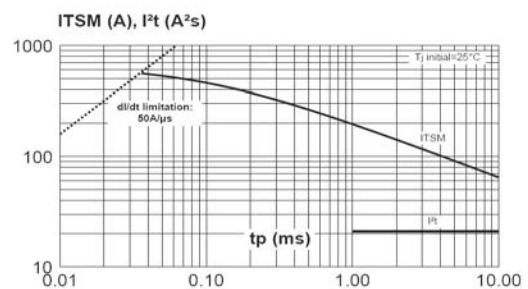

Fig. 6: Non-repetitive surge peak on-state current for a sinusoidal pulse with width $t_p < 10\text{ms}$, and corresponding value of I^2t .



Description

Fig. 1: Maximum power dissipation versus RMS on-state current (full cycle).

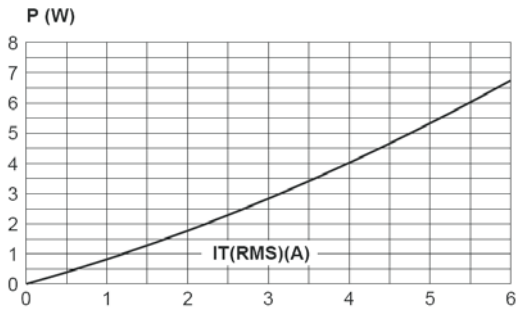

Fig. 2: RMS on-state current versus case temperature (full cycle).

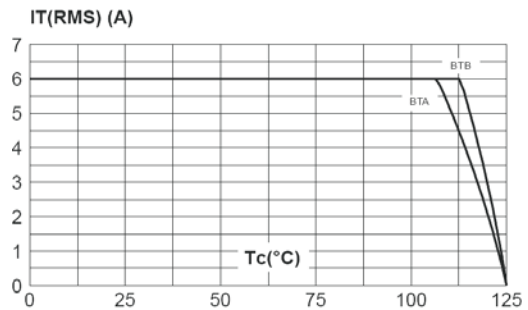

Fig. 3: Relative variation of thermal impedance versus pulse duration.

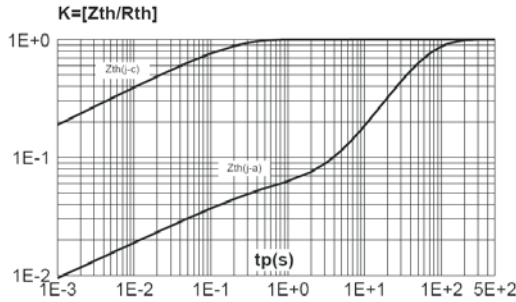

Fig. 4: On-state characteristics (maximum values).

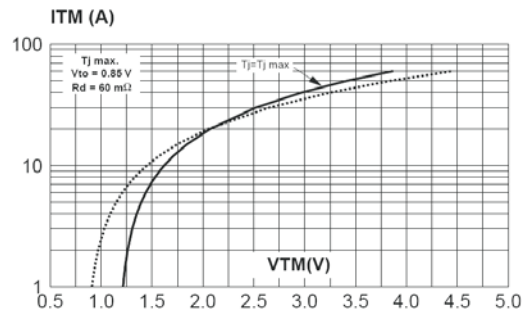

Fig. 5: Surge peak on-state current versus number of cycles.

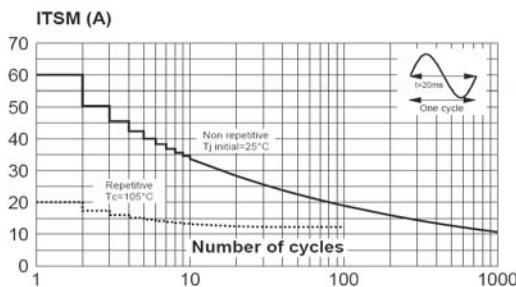
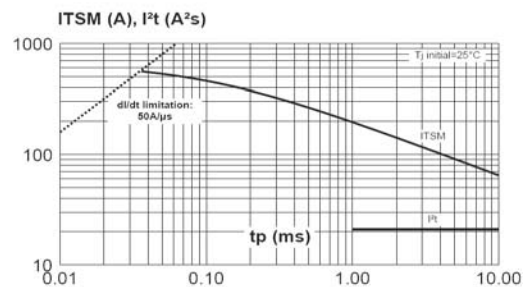
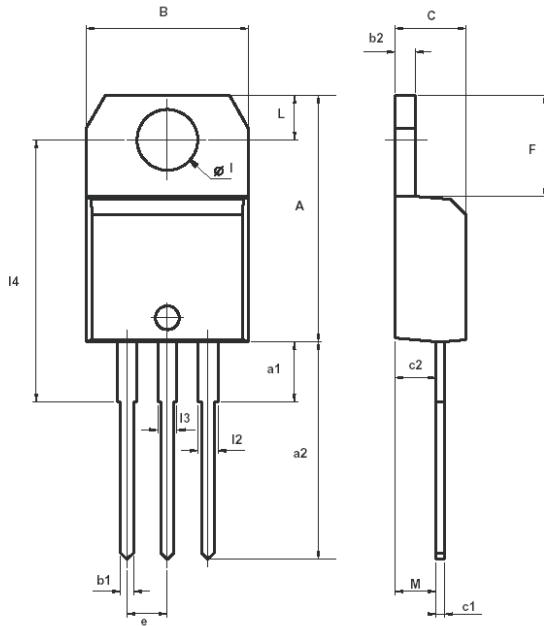

Fig. 6: Non-repetitive surge peak on-state current for a sinusoidal pulse with width tp < 10ms, and corresponding value of I²t.



MECHANICAL DATA

Dimensions in mm
Net Mass: 2 g



REF.	DIMENSIONS					
	Millimeters			Inches		
	Min.	Typ.	Max.	Min.	Typ.	Max.
A	15.20		15.90	0.598		0.625
a1		3.75			0.147	
a2	13.00		14.00	0.511		0.551
B	10.00		10.40	0.393		0.409
b1	0.61		0.88	0.024		0.034
b2	1.23		1.32	0.048		0.051
C	4.40		4.60	0.173		0.181
c1	0.49		0.70	0.019		0.027
c2	2.40		2.72	0.094		0.107
e	2.40		2.70	0.094		0.106
F	6.20		6.60	0.244		0.259
l	3.75		3.85	0.147		0.151
i4	15.80	16.40	16.80	0.622	0.646	0.661
L	2.65		2.95	0.104		0.116
i2	1.14		1.70	0.044		0.066
i3	1.14		1.70	0.044		0.066
M		2.60			0.102	