



HAOPIN MICROELECTRONICS CO.,LTD.

Description

Passivated high commutation triacs in a plastic envelope intended for use in circuits where high static and dynamic dV/dt and high dI/dt can occur. These devices will commute the full rated ms current at the maximum rated junction temperature without the aid of a snubber.

<p>Symbol</p> 		<p>Simplified outline</p> 	
Pin	Description		
1	Main terminal 1 (T1)		
2	Main terminal 2 (T2)		
3	gate (G)		
TAB	Main terminal 2(T2)		

Applications:

- ◆ Motor control
- ◆ Industrial and domestic lighting
- ◆ Heating
- ◆ Static switching

Features

- ◆ Blocking voltage to 600 V
- ◆ On-state RMS current to 4 A

SYMBOL	PARAMETER	Value	Unit
V_{DRM}	Repetitive peak off-state voltages	600	V
$I_T (RMS)$	RMS on-state current (full sine wave)	4	A
I_{TSM}	Non-repetitive peak on-state current (full cycle, T_j initial=25°C)	30	A

SYMBOL	PARAMETER	CONDITIONS	MIN	TYP	MAX	UNIT
$R_{th(j-c)}$	Junction to case(AC)		-	2.6	-	°C/W
$R_{th(j-a)}$	Junction to ambient		-	60	-	°C/W

HAOPIN MICROELECTRONICS CO.,LTD.

Limiting values in accordance with the Maximum system(IEC 134)

SYMBOL	PARAMETER	CONDITIONS	MIN	MAX	UNIT
V_{DRM}	Repetitive peak off-state Voltages		-	600	V
$I_{T(RMS)}$	RMS on-state current Full sine wave	$T_c=110^{\circ}C$	-	4	A
I^2t	I^2t value for fusing	$T_p=10ms$	-	5.1	A^2s
DI/dt	Critical rate of rise of on-state current $I_G=2 \times I_{GT}, tr \leq 100 ns$	$F=120Hz \quad T_j=125^{\circ}C$	-	50	$A/\mu s$
I_{GM}	Peak gate current	$T_p=20 \mu s \quad T_j=125^{\circ}C$	-	4	A
V_{GD}		$V_D=V_{DRM}; R_L=33k\Omega \quad T_j=125^{\circ}C$	0.2	-	V
V_{GT}		$V_D=12V; R_L=30\Omega$	-	1.3	V
$P_{G(AV)}$	Average gate power	$T_j=125^{\circ}C$	-	1	W
T_{stg}	Storage temperature		-40	150	$^{\circ}C$
T_j	Operating junction Temperature range		-40	125	$^{\circ}C$

$T_j=25^{\circ}C$ unless otherwise stated

SYMBOL	PARAMETER	CONDITIONS	MIN	TYP	MAX	UNIT
Static characteristics						
I_{GT}	Gate trigger current	$V_D=12V; R_L=30\Omega$ I-II-III	-	-	5	mA
I_L	Latching current	$I_G=1.2I_{GT}$ I-III II	-	-	10 15	mA
I_{DRM} I_{RRM}	$V_{DRM}=V_{RRM}$	$T_j=25^{\circ}C$ $T_j=125^{\circ}C$	-	-	5 1	μA mA
I_H	Holding current	$I_T=100mA$	-	-	10	mA
V_{TM}	$I_{TM}=5.5A \quad t_p=380 \mu s$	$T_j=25^{\circ}C$	-	-	1.6	V
V_{TO}	Threshold voltage	$T_j=125^{\circ}C$	-	-	0.9	V
R_D	Dynamic resistance	$T_j=125^{\circ}C$	-	-	120	$M\Omega$

Dynamic Characteristics

D_V/dt	Critical rate of rise of Off-state voltage	$V_D=67\% V_{DRM}$ gate open; $T_j=125^{\circ}C$;	20	-	-	$V/\mu s$
$(di/dt)_c$		$(dV/dt)_c=0.1V/\mu s \quad T_j=125^{\circ}C$ $(dv/dt)_c=10V/\mu s \quad T_j=125^{\circ}C$	1.8 0.9	-	-	A/ms

Description

Fig. 1: Maximum power dissipation versus RMS on-state current (full cycle).

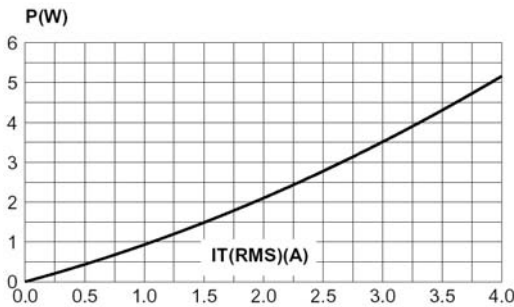

Fig. 2-1: RMS on-state current case versus temperature (full cycle).

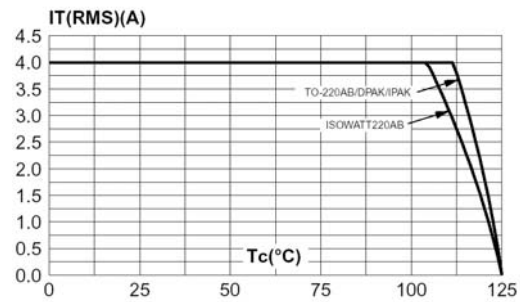

Fig. 2-2: RMS on-state current versus ambient temperature (printed circuit FR4, copper thickness: 35 μ m), full cycle.

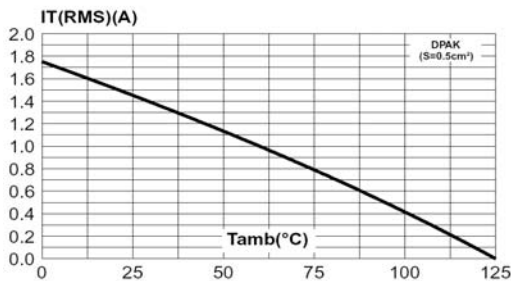

Fig. 3: Relative variation of thermal impedance versus pulse duration.

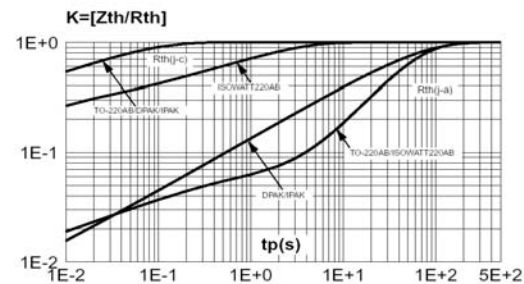

Fig. 4: Relative variation of gate trigger current, holding current and latching current versus junction temperature (typical values).

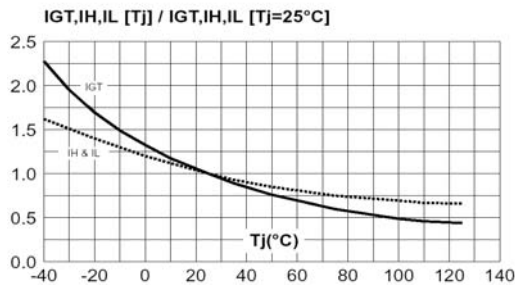
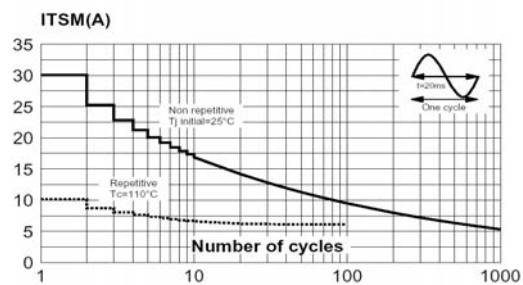

Fig. 5: Surge peak on-state current versus number of cycles.



HAOPIN MICROELECTRONICS CO.,LTD.

Description

Fig. 6: Non-repetitive surge peak on-state current for a sinusoidal pulse with width $t_p < 10\text{ms}$, and corresponding value of I^2t .

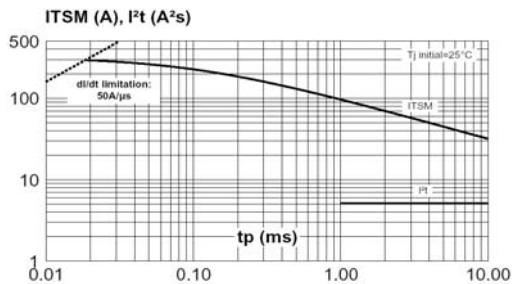

Fig. 7: On-state characteristics (maximum values).

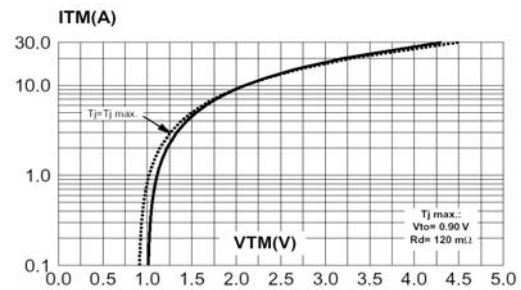

Fig. 8: Relative variation of critical rate of decrease of main current versus $(dV/dt)_c$ (typical values).

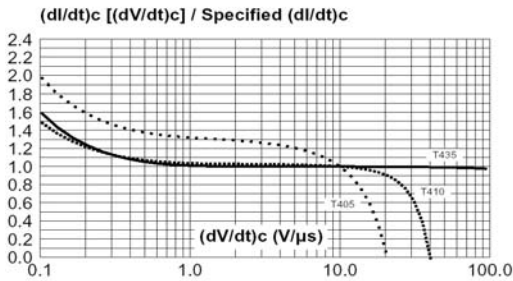

Fig. 9: Relative variation of critical rate of decrease of main current versus junction temperature.

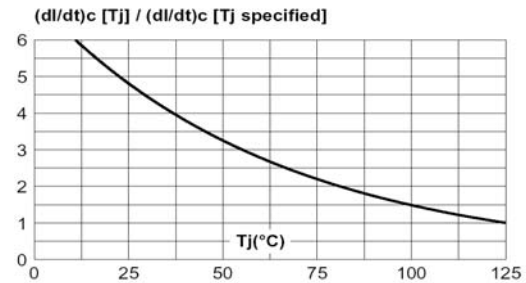
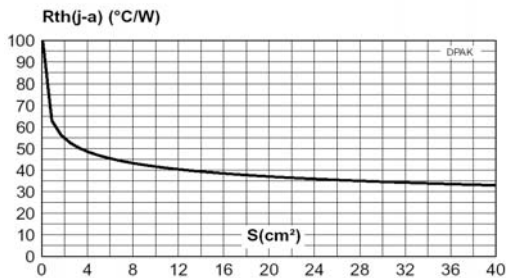
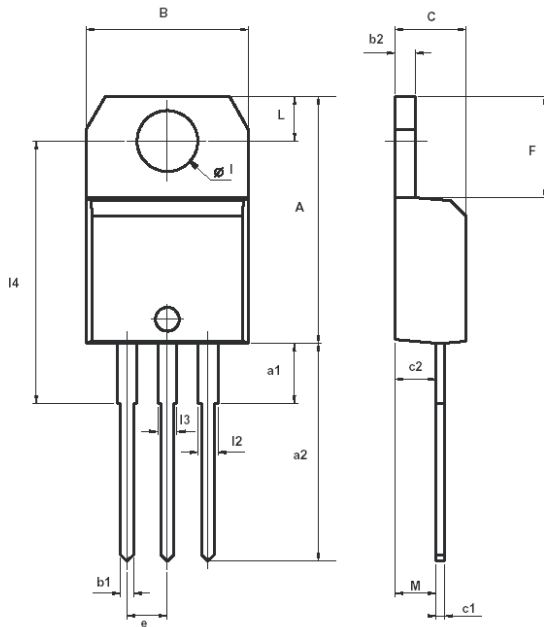

Fig. 10: DPAK thermal resistance junction to ambient versus copper surface under tab (printed circuit board FR4, copper thickness: $35\mu\text{m}$).



MECHANICAL DATA

Dimensions in mm
 Net Mass: 2.3 g
 TO-220



REF.	DIMENSIONS					
	Millimeters			Inches		
	Min.	Typ.	Max.	Min.	Typ.	Max.
A	15.20		15.90	0.598		0.625
a1		3.75			0.147	
a2	13.00		14.00	0.511		0.551
B	10.00		10.40	0.393		0.409
b1	0.61		0.88	0.024		0.034
b2	1.23		1.32	0.048		0.051
C	4.40		4.60	0.173		0.181
c1	0.49		0.70	0.019		0.027
c2	2.40		2.72	0.094		0.107
e	2.40		2.70	0.094		0.106
F	6.20		6.60	0.244		0.259
I	3.75		3.85	0.147		0.151
l4	15.80	16.40	16.80	0.622	0.646	0.661
L	2.65		2.95	0.104		0.116
l2	1.14		1.70	0.044		0.066
l3	1.14		1.70	0.044		0.066
M		2.60			0.102	